

NCP5667

3.0 A, Low Dropout Linear Regulator with Enhanced ESD Protection

The NCP5667 is a high performance, low dropout linear regulator designed for high power applications that require up to 3.0 A current. A thermally robust, 3 pin D²PAK, combined with an architecture that offers low ground current (independent of load), provides for a superior high-current LDO solution.

Features

- ±1% Output Voltage Accuracy
- Ultra-Fast Transient Response (Settling Time: 1–3 μs)
- Enhanced ESD Ratings: 4 kV (HBM), 400 V (MM)
- Low Ground Current Independent of Load (3.0 mA Maximum)
- Current Limit Protection
- Thermal Protection
- Power Supply Rejection Ratio > 65 dB
- Stable with Aluminum, Tantalum and Ceramic Capacitors
- Functional Substitute for LM323
- This is a Pb-Free Device

Applications

- Servers
- DTV and Flat Panel Applications
- Post Regulation for Power Supplies
- Laptop Computing Applications
- USB Powered Applications
- Networking Equipment
- Gaming and STB Modules

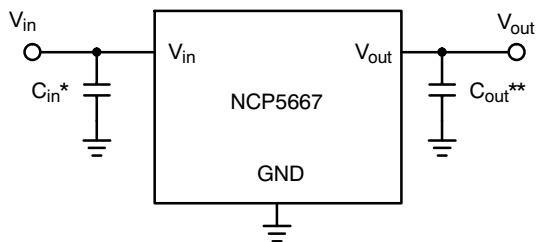

* C_{in} – 4.7 μF to 220 μF recommended

**C_{out} – 2.2 μF to 220 μF recommended

See more details in the Application Information section

Figure 1. Typical Application Circuit



ON Semiconductor®

<http://onsemi.com>

MARKING DIAGRAM

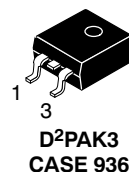

xx = Voltage Option
50 = 5.0 V

A = Assembly Location

WL = Wafer Lot

Y = Year

WW = Work Week

G = Pb-Free

Tab = GND

Pin 1. V_{in}
2. GND
3. V_{out}

ORDERING INFORMATION

See detailed ordering and shipping information in the package dimensions section on page 8 of this data sheet.

NCP5667

PIN FUNCTION DESCRIPTION

Pin No.	Pin Name	Description
1	V_{in}	Positive Power Supply Input Voltage
2, Tab	GND	Power Supply Ground
3	V_{out}	Regulated Output Voltage

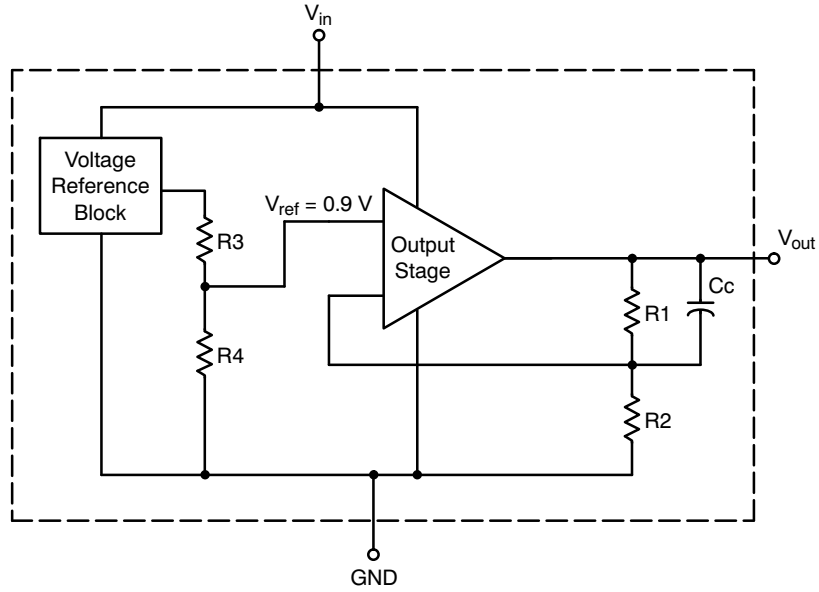

Figure 2. Block Diagram

NCP5667

ABSOLUTE MAXIMUM RATINGS

Rating	Symbol	Value	Unit
Input Voltage (Note 1)	V_{in}	18	Vdc
Output Pin Voltage	V_{out}	-0.3 to ($V_{in} + 0.3$)	V
Maximum Junction Temperature	$T_{J(max)}$	150	°C
Storage Temperature Range	T_{stg}	-55 to +150	°C
Moisture Sensitivity Level	MSL	1	-
ESD Capability, Human Body Model (Note 2)	ESD _{HBM}	4000	V
ESD Capability, Machine Model (Note 2)	ESD _{MM}	400	V

Stresses exceeding Maximum Ratings may damage the device. Maximum Ratings are stress ratings only. Functional operation above the Recommended Operating Conditions is not implied. Extended exposure to stresses above the Recommended Operating Conditions may affect device reliability.

THERMAL CHARACTERISTICS

Rating	Symbol	Value	Unit
Thermal Characteristics (Note 1) Thermal Resistance Junction-to-Ambient (Note 3) Thermal Resistance Junction-to-Case	$R_{\theta JA}$ $R_{\theta JC}$	45 5.0	°C/W

OPERATING RANGES

Rating	Symbol	Value	Unit
Operating Input Voltage (Note 1)	V_{in}	($V_{out} + V_{DO}$) to 9	V
Operating Ambient Temperature Range	T_A	-40 to +85	°C

1. Refer to Electrical Characteristics and Application Information for Safe Operating Area.
2. This device series contains ESD protection and exceeds the following tests:
Human Body Model (HBM) JESD 22-A114-B
Machine Model (MM) JESD 22-A115-A.
3. As measured using a copper heat spreading area of 650 mm², 1 oz copper thickness.

NCP5667

ELECTRICAL CHARACTERISTICS ($V_{in} = V_{out(nom)} + 1.5$ V, for typical values $T_A = 25^\circ\text{C}$, for min/max values $T_A = -40^\circ\text{C}$ to 85°C , $C_{in} = 100 \mu\text{F}$, $C_{out} = 33 \mu\text{F}$, unless otherwise noted. (Note 4))

Characteristic	Symbol	Min	Typ	Max	Unit
Output Voltage (Note 6) 5.0 V Regulator $T_A = 25^\circ\text{C}$ ($V_{in} = 6.5$ V to 7.0 V, $I_{out} = 10$ mA to 3.0 A) $T_A = -20$ to $+125^\circ\text{C}$ ($V_{in} = 6.5$ V to 7.0 V, $I_{out} = 10$ mA to 3.0 A) $T_A = -40$ to $+150^\circ\text{C}$ ($V_{in} = 6.5$ V to 7.0 V, $I_{out} = 10$ mA to 3.0 A)	V_{out}	4.950 (-1%) 4.925 (-1.5%) 4.900 (-2%)	5.000 5.000 5.000	5.050 (+1%) 5.075 (+1.5%) 5.100 (+2%)	V
Line Regulation ($I_{out} = 10$ mA, $V_{out} + 1.5$ V < V_{in} < 7.0 V) (Note 5)	REG_{line}	-	0.03	-	%
Load Regulation (10 mA < I_{out} < 3.0 A) (Note 5)	REG_{load}	-	0.2	-	%
Dropout Voltage ($I_{out} = 3.0$ A)	V_{DO}	-	1.0	1.3	V
Peak Output Current Limit	I_{out}	3.0	-	-	A
Internal Current Limitation (Note 5)	I_{lim}	-	4.5	-	A
Ripple Rejection (120 Hz) (Note 5)	RR	-	70	-	dB
Ripple Rejection (1 kHz) (Note 5)		-	65	-	
Output Noise Voltage ($I_{out} = 10$ mA, $C_{out} = 1.0 \mu\text{F}$, $f = 10$ Hz to 100 kHz) (Note 5)	V_n	-	105	-	μV_{rms}
Thermal Shutdown (Note 5)	T_{SHD}	-	160	-	$^\circ\text{C}$
Ground Current ($I_{out} = 3.0$ A)	I_{GND}	-	2.4	3.0	mA

4. Performance guaranteed over specified operating conditions by design, guard banded test limits, and/or characterization, production tested at $T_J = T_A = 25^\circ\text{C}$. Low duty cycle pulse techniques are used during testing to maintain the junction temperature as close to ambient as possible.
5. Typical values are based on design and/or characterization.
6. Other fixed output voltages available at 0.9 V, 1.2 V, 1.5 V, 1.8 V, 2.5 V, 3.0 V, 3.3 V per request.

TYPICAL CHARACTERISTICS

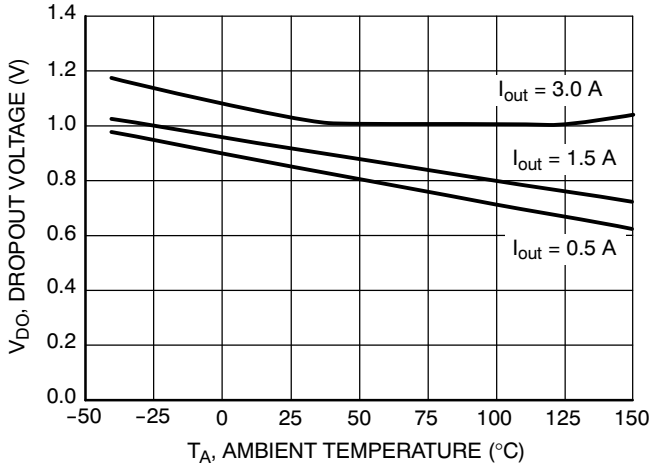

Figure 1. Dropout Voltage vs. Ambient Temperature

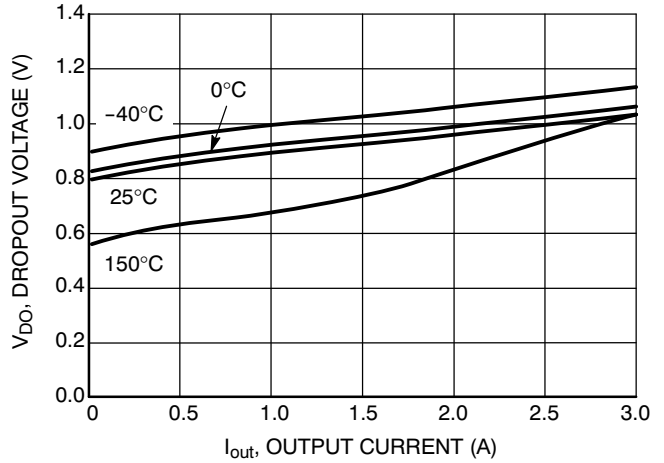

Figure 2. Dropout Voltage vs. Output Current

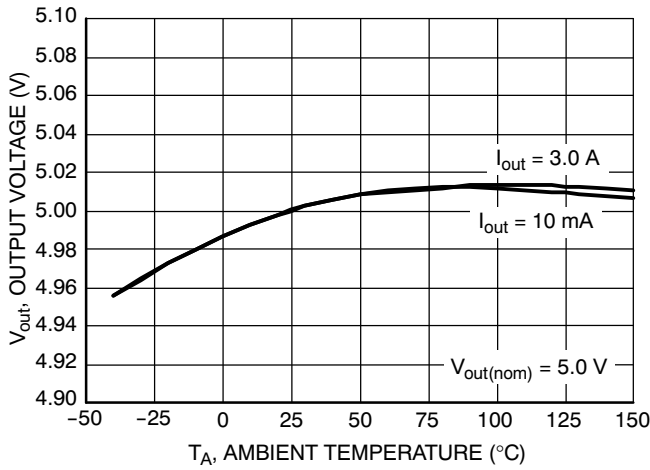

Figure 3. Output Voltage vs. Ambient Temperature

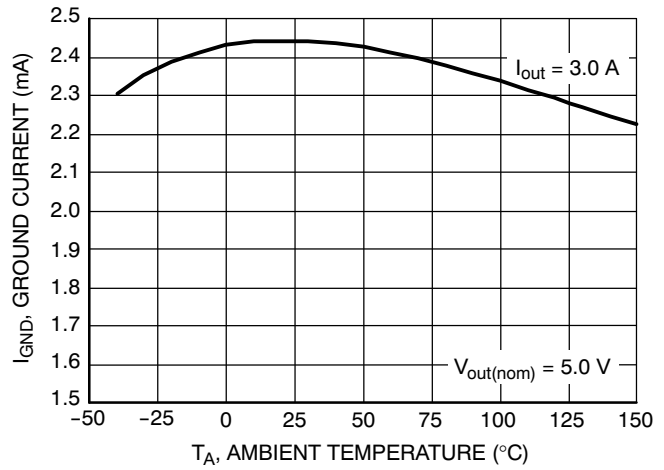

Figure 4. Ground Current vs. Ambient Temperature

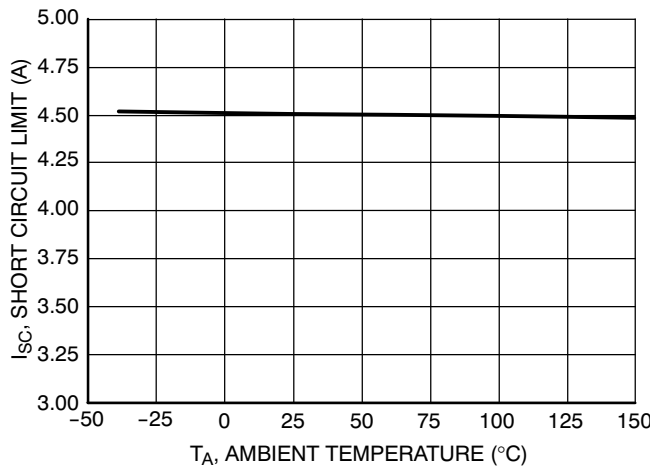

Figure 5. Short Circuit Current Limit vs. Ambient Temperature

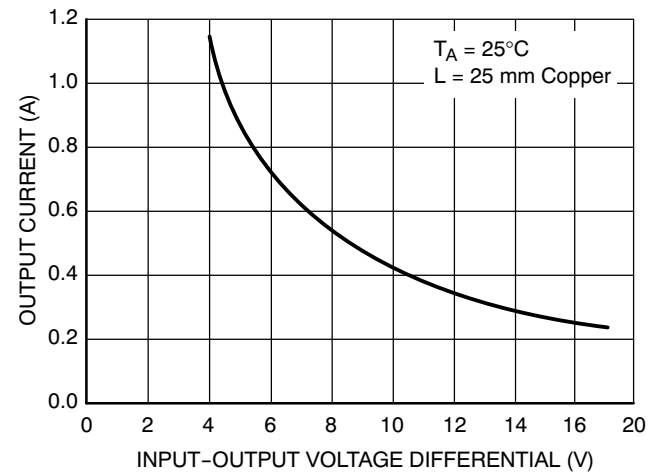

Figure 6. Output Current vs. Input-Output Voltage Differential

TYPICAL CHARACTERISTICS

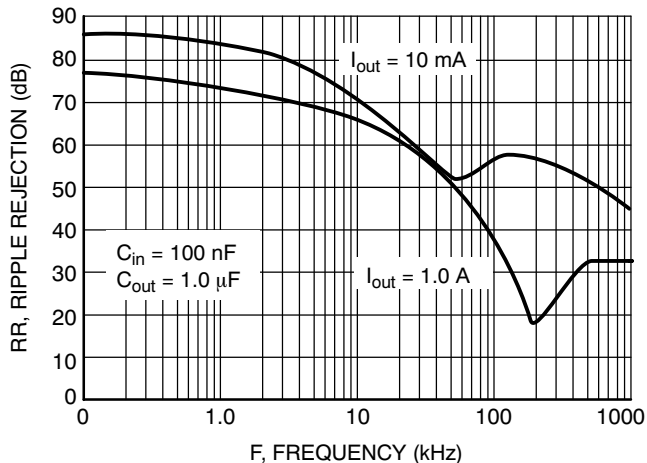

Figure 7. Ripple Rejection vs. Frequency

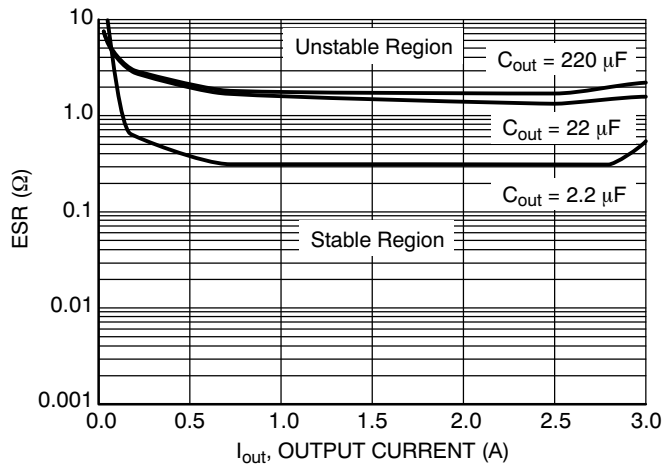
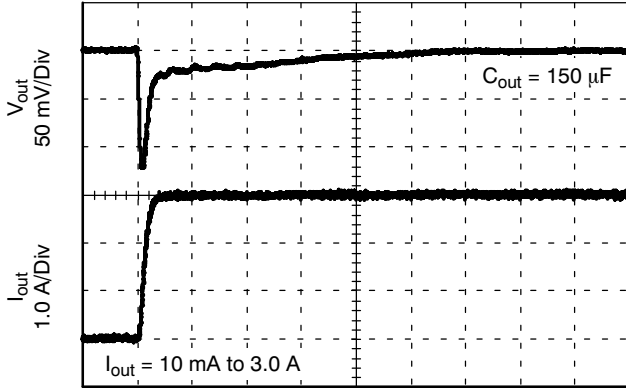

Figure 8. Output Capacitor ESR Stability vs. Output Current

TYPICAL CHARACTERISTICS



TIME (1.0 μs/Div)

Figure 9. Load Transient Response

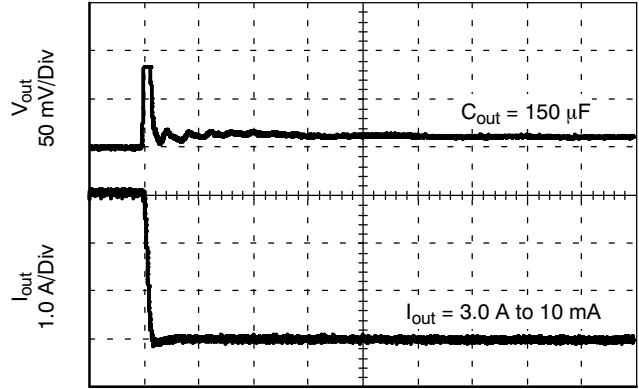

TIME (1.0 μs/Div)

Figure 10. Load Transient Response

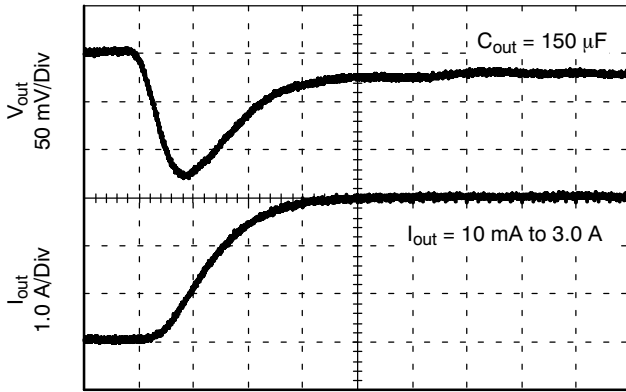

TIME (100 ns/Div)

Figure 11. Load Transient Response

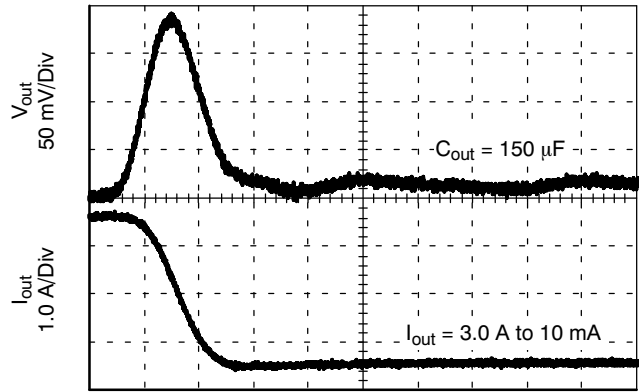

TIME (100 ns/Div)

Figure 12. Load Transient Response

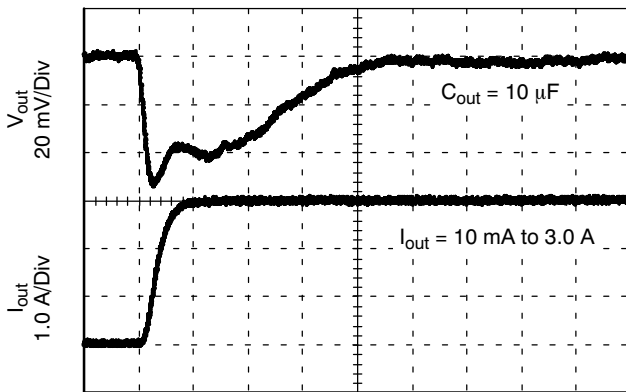

TIME (400 ns/Div)

Figure 13. Load Transient Response

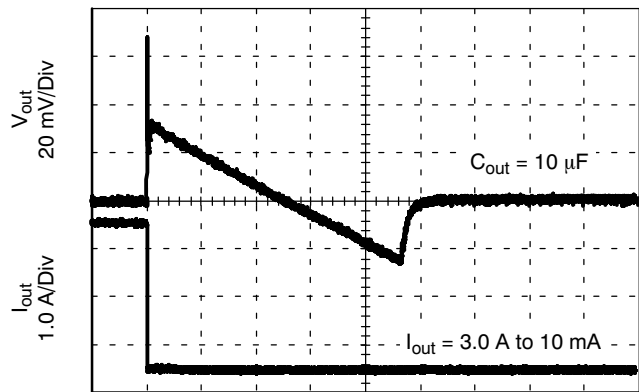

TIME (10 μs/Div)

Figure 14. Load Transient Response

NOTE: Typical characteristics were measured with the same conditions as electrical characteristics, unless otherwise noted.

APPLICATION INFORMATION

The NCP5667 is a high performance low dropout 3.0 A linear regulator suitable for high power applications. It is thermally robust and includes the safety features necessary during a fault condition, which provide for an attractive high current LDO solution for server, ASIC power supplies, networking equipment applications, and many others.

Input Capacitor

An input bypass capacitor is recommended to improve transient response or if the regulator is located more than a few inches from the power source. This will reduce the circuit's sensitivity to the input line impedance at high frequencies and significantly enhance the output transient response. Different types and different sizes of input capacitors can be chosen dependent on the quality of power supply. The range of 4.7 µF to 220 µF should cover most of the applications. The higher the capacitance, the lower change of input voltage due to line and load transients. The bypass capacitor should be mounted with shortest possible lead or track length directly across the regulator's input terminals.

Output Capacitor

The output capacitor is required for stability. The NCP5667 remains stable with ceramic, tantalum, and aluminum electrolytic capacitors with a minimum value of 2.2 µF. See Figure 8 for stable region of ESR for various output capacitors. The range of 2.2 µF to 220 µF should cover most of the applications. The higher the capacitance, the better load transient response. When a high value capacitor is used, a low value capacitor is also recommended to be put in parallel. The output capacitors should be placed as close as possible to the output pin of the device. This should help ensure ultrafast transient response times.

Current Limit Operation

As the peak output current increases beyond its limitation, the device is internally clamped to 4.5 A, thus causing the output voltage to decrease and go out of regulation. This allows the device never to exceed the maximum power dissipation.

Input Voltage Operating Range

The NCP5667 is guaranteed to protect itself from self destruction due to excessive power dissipation by activating current limit and thermal shutdown protections. These destructive situations can happen during very fast startup with large output capacitors or when output is short circuited. As long as the input voltage is lower than maximum operating voltage (9 V), the maximum power dissipation is never exceeded.

If input voltage is between maximum operating voltage (9 V) and absolute maximum voltage (18 V) power dissipation must never exceed limits specified in Thermal Consideration section for safety operation.

To use the device over maximum operating voltage the slow startup, not large output capacitors and no short circuit is recommended to maintain.

Thermal Consideration

The maximum device power dissipation can be calculated by:

$$P_D = \frac{T_{J(max)} - T_A}{R_{\theta JA}}$$

The bipolar process employed for this IC is fully characterized and rated for reliable 18 V operation. To avoid damaging the part or degrading its reliability, power dissipation transients should be limited to 30 W for D²PAK. For open-circuit to short-circuit transient,

$$PD_{Transient} = V_{in(operating\ max)} * ISC$$

ORDERING INFORMATION

Device	Nominal Output Voltage	Package	Shipping†
NCP5667DS50R4G (Note 7)	5.0 V	D ² PAK (Pb-Free)	800 / Tape & Reel

7. Other fixed output voltages available at 0.9 V, 1.2 V, 1.5 V, 1.8 V, 2.5 V, 3.0 V, 3.3 V per request.

†For information on tape and reel specifications, including part orientation and tape sizes, please refer to our Tape and Reel Packaging Specifications Brochure, BRD8011/D.

NCP5667

PACKAGE DIMENSIONS

D2PAK CASE 936-03 ISSUE B

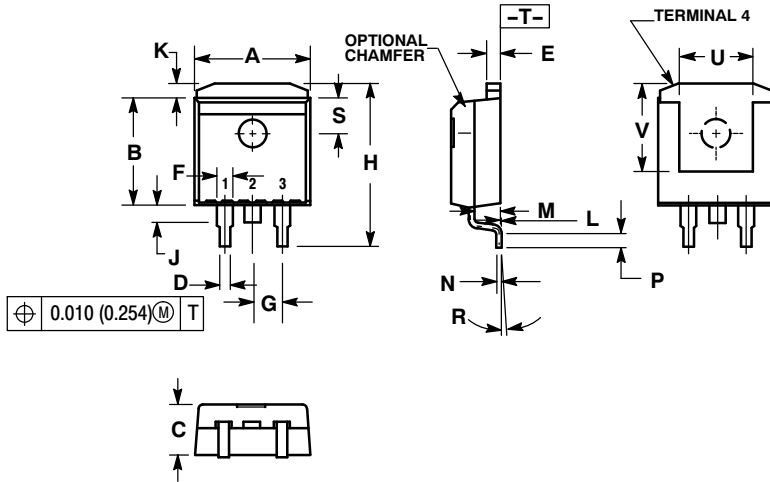

NOTES:

1. DIMENSIONING AND TOLERANCING PER ANSI Y14.5M, 1982.
2. CONTROLLING DIMENSION: INCH.
3. TAB CONTOUR OPTIONAL WITHIN DIMENSIONS A AND K.
4. DIMENSIONS U AND V ESTABLISH A MINIMUM MOUNTING SURFACE FOR TERMINAL 4.
5. DIMENSIONS A AND B DO NOT INCLUDE MOLD FLASH OR GATE PROTRUSIONS. MOLD FLASH AND GATE PROTRUSIONS NOT TO EXCEED 0.025 (0.635) MAXIMUM.

DIM	INCHES		MILLIMETERS	
	MIN	MAX	MIN	MAX
A	0.386	0.403	9.804	10.236
B	0.356	0.368	9.042	9.347
C	0.170	0.180	4.318	4.572
D	0.026	0.036	0.660	0.914
E	0.045	0.055	1.143	1.397
F	0.051 REF		1.295 REF	
G	0.100 BSC		2.540 BSC	
H	0.539	0.579	13.691	14.707
J	0.125 MAX		3.175 MAX	
K	0.050 REF		1.270 REF	
L	0.000	0.010	0.000	0.254
M	0.088	0.102	2.235	2.591
N	0.018	0.026	0.457	0.660
P	0.058	0.078	1.473	1.981
R	5° REF		5° REF	
S	0.116 REF		2.946 REF	
U	0.200 MIN		5.080 MIN	
V	0.250 MIN		6.350 MIN	

The products described herein (NCP5667), may be covered by one or more of the following U.S. patents: 5,920,184; 5,834,926. There may be other patents pending.

ON Semiconductor and **ON** are registered trademarks of Semiconductor Components Industries, LLC (SCILLC). SCILLC reserves the right to make changes without further notice to any products herein. SCILLC makes no warranty, representation or guarantee regarding the suitability of its products for any particular purpose, nor does SCILLC assume any liability arising out of the application or use of any product or circuit, and specifically disclaims any and all liability, including without limitation special, consequential or incidental damages. "Typical" parameters which may be provided in SCILLC data sheets and/or specifications can and do vary in different applications and actual performance may vary over time. All operating parameters, including "Typicals" must be validated for each customer application by customer's technical experts. SCILLC does not convey any license under its patent rights nor the rights of others. SCILLC products are not designed, intended, or authorized for use as components in systems intended for surgical implant into the body, or other applications intended to support or sustain life, or for any other application in which the failure of the SCILLC product could create a situation where personal injury or death may occur. Should Buyer purchase or use SCILLC products for any such unintended or unauthorized application, Buyer shall indemnify and hold SCILLC and its officers, employees, subsidiaries, affiliates, and distributors harmless against all claims, costs, damages, and expenses, and reasonable attorney fees arising out of, directly or indirectly, any claim of personal injury or death associated with such unintended or unauthorized use, even if such claim alleges that SCILLC was negligent regarding the design or manufacture of the part. SCILLC is an Equal Opportunity/Affirmative Action Employer. This literature is subject to all applicable copyright laws and is not for resale in any manner.

PUBLICATION ORDERING INFORMATION

LITERATURE FULFILLMENT:

Literature Distribution Center for ON Semiconductor
P.O. Box 5163, Denver, Colorado 80217 USA
Phone: 303-675-2175 or 800-344-3860 Toll Free USA/Canada
Fax: 303-675-2176 or 800-344-3867 Toll Free USA/Canada
Email: orderlit@onsemi.com

N. American Technical Support: 800-282-9855 Toll Free
USA/Canada
Europe, Middle East and Africa Technical Support:
Phone: 421 33 790 2910
Japan Customer Focus Center
Phone: 81-3-5773-3850

ON Semiconductor Website: www.onsemi.com

Order Literature: <http://www.onsemi.com/orderlit>

For additional information, please contact your local Sales Representative